



 **kratki.pl**



*Vytvárame príjemnú atmosféru...*





## SYMBOLY POUŽITÉ V KATALÓGU

---

 nominálny výkon (kW)

 min. - max. výkon(kW)

 tepelná účinnosť (%)

 priemer dymovodu (mm)

 hmotnosť (kg)

 dĺžka polien (mm)

 nominálny výkon do vody (kW)

 materiál

 rovné presklenie

 ľavé bočné presklenie

 pravé bočné presklenie

 trojstranné presklenie

 obojstranné presklenie

 obojstranné + ľavé bočné presklenie

 obojstranné + pravé bočné presklenie

 štvorstranné presklenie

 prizmatické presklenie

 oblé presklenie

 výsuvné dvierka

 obojstranné výsuvné dvierka

 LUX

 DECO

 ľavé bočné presklenie bez stĺpika

 pravé bočné presklenie bez stĺpika

 trojstranné presklenie bez stĺpika

 výsuvné dverka - pravé bočné presklenie bez stĺpika

 výsuvné dverka - ľavé bočné presklenie bez stĺpika

 krbová vložka spĺňa normy BlmschV 2

 krbová vložka vhodná do domov s rekuperáciou

 novinka

#### Rozmery:

---

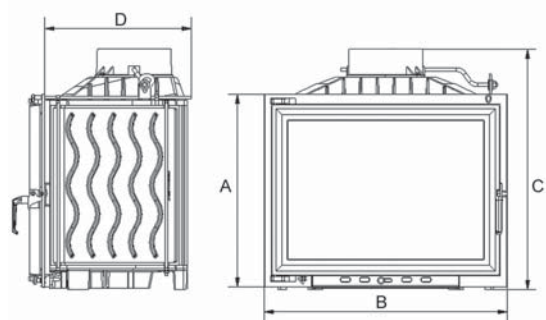

A x B x C x D

Uvedené rozmery sú pre voľne stojace kachle a krby s rovným presklením, základná verzia.



Antek

491x600x622x334



10 kW, <kW< 6-13, 62, 180, 94, 330

Wiktor

515x738x645x384



14 kW, <kW< 7-18, 70, 200, 110, 450

Maja

491x600x701x360



11 kW, <kW< 5,7-14,5, 75, 200, 115, 330

Zuzia

515x652x810x442

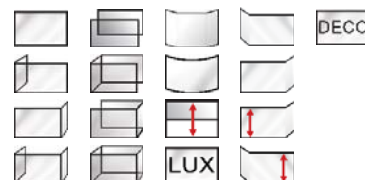

16 kW, <kW< 8-22, 70, 200, 149, 500

Eryk

515x652x644x383



12 kW, <kW< 8-16, 70, 200, 104, 350

Felix

607x750x737x384







16 kW, <kW< 8-22, 73, 200, 125, 450

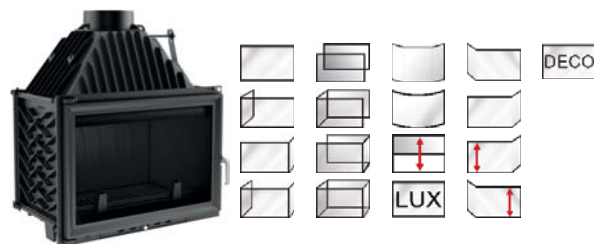

Oliwia

515x738x810x443





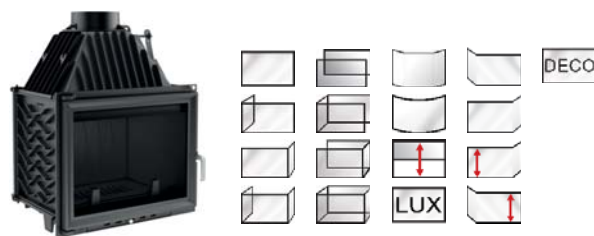

- kW  
18
- <kW>  
9-23
-  79
-  200
-  162
-  500

Amelia

607x750x902x443,5







- kW  
21
- <kW>  
11,5-29
-  75
-  200
-  183
-  500

Maja Wieża

1118x759x1118x365



- kW  
15
- <kW>  
7-19,5
-  71
-  200
-  155
-  330

## Zuzia Eko

543x652x833x455

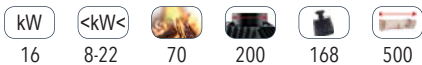

## Amelia Eko

635x750x925x455

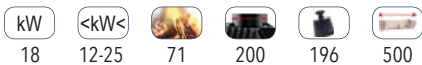

## Natala

903x764x1096x362

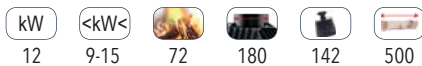

Mila

606x1132x1034x449

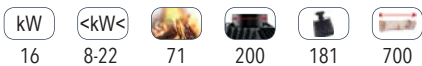

Jaś

450x676x543x306

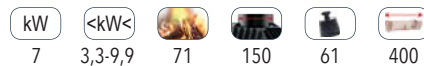

Ala

828x612x1480x594

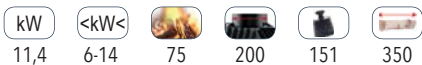

Atena

378x768x634x417

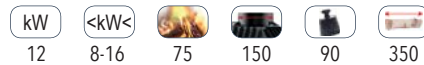

Basia

625x900x759x487

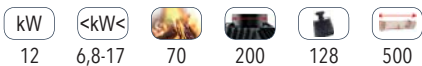

Zibi

969,5x834x1211x445

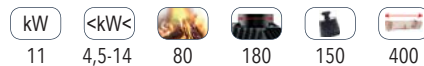













**Blanka**

610x450x1009x450









 kW	 <kW<				
8	7,5-11	78	160	117	300

**Blanka 670/570**

576x676x974,5x453









 kW	 <kW<				
11	7,1-14,5	81	180	148	500

**Blanka 910**

559,5x910x956,5x453



 kW	 <kW<				
16	7,5-21,5	83	200	185	500

Frnek

540x700x968x476

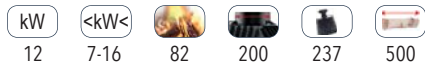

MBO

510x830x1440x473

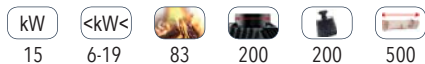

MBM

450x703x1261x428

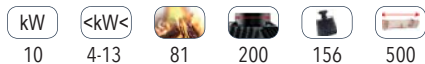



### Nadia 8

969,5x484x1211x445

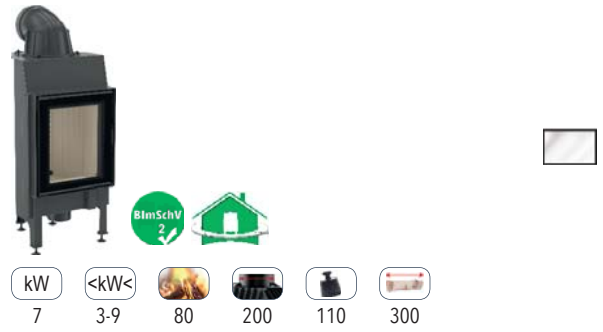

### Nadia 10

969,5x684x1211x445



### Nadia 12

606x1132x1034x449



Nadia 13

640x834x1331x418



kW

13

<kW<

7-16



82



200



160



400

Nadia 14

920,5x979x1162x445



kW

14

<kW<

6,5-17



80



200



177



500



**Antek/PW**

491x600x677x380

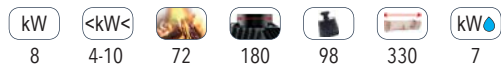
**Wiktor/PW**

515x738x703x421

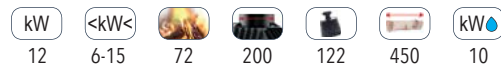
**Eryk/PW**

515x652x701x421

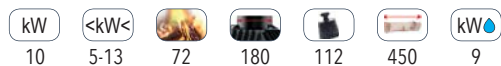
**Felix/PW**

607x750x792x421

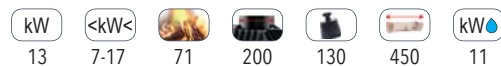
**Maja/PW**

491x600x677x390

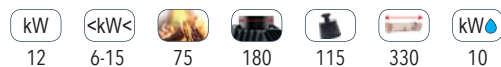
**Zuzia/PW**

515x652x869x471

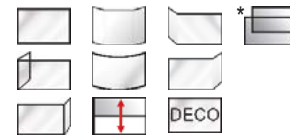

\*len vo verzii 19 kW







Oliwia/PW

515x738x868x471

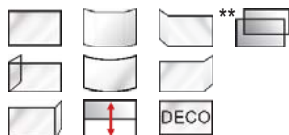

**kW** **<kW<** **kW**  
17 / 22 8-23 / 11-29 75 / 75 200 / 200 171 / 181 500 / 500 13 / 18

Amelia/PW

607x750x960x471



**kW** **<kW<** **kW**  
24 / 28 11-30 / 13-35 78 / 75 220 / 220 187 / 200 500 / 500 20 / 24

Natala/PW

903x764x1118x437



**kW** **<kW<** **kW**  
14 7-14 76 180 156 500 13

\*\*len vo verzii 22kW, \*\*\* len vo verzii 24kW











**Mila/PW**

606x1132x1034x448









 kW	 <kW>					 kW
24	11-30	78	200	213	700	12

**Zuzia NP**

515x652x1138x471









 kW	 <kW>					 kW
24	18-28	81	200	217	500	21

**Zuzia DIN DECO**

520x652x869x495



 kW	 <kW>					 kW
11	11-15	88,4	200	200	500	7

Nadia/PW

512x650x1390416



kW

11

<kW<

5-13,5



82



200



192



350

kW

6





Aquario M8

Aquario M12



Aquario Z10

Aquario Z14



Aquario O12







Aquario O16



Aquario A14

Aquario A18



	AQUARIO /M/8/W	AQUARIO /M/12/W	AQUARIO /Z/10/W	AQUARIO /Z/14/W	AQUARIO /O/12/W	AQUARIO /O/16/W	AQUARIO /A/14/W	AQUARIO /A/18/W
 kW	8	12	9	12	12	16	14	18
 kW	5,5	8,1	7,1	10,6	8,4	10,8	9,8	12,5
 <kW	5-10	8-14	5-11	7-14	8-16	8-16	8-16	10-18
	180	180	200	200	200	200	200	200
	81,7	86,7	82,5	86	83,1	84,4	84,3	86,5
	213	236	250	283	280	312	290	331
	450	450	550	550	550	550	500	500

#### Rozměry:

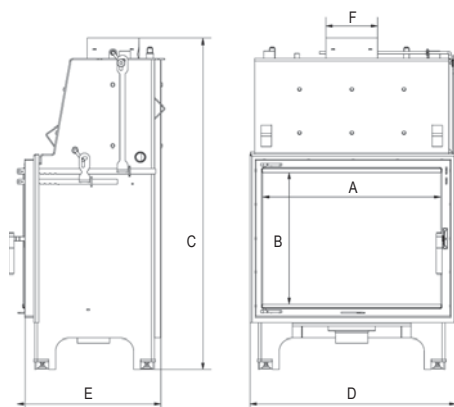

	A	B	C	D	E	F
AQUARIO/M/8/W	464	334	1001	637	442	ø180
AQUARIO/M/12/W	464	334	1201	637	442	ø180
AQUARIO/Z/10/W	519	358	1181	692	524	ø200
AQUARIO/Z/14/W	519	358	1335	692	524	ø200
AQUARIO/O/12/W	605	358	1181	778	524	ø200
AQUARIO/O/16/W	605	358	1335	778	524	ø200
AQUARIO/A/14/W	605	448	1273	790	524	ø200
AQUARIO/A/18/W	605	448	1427	790	524	ø200





### Piecyk kaflowy Blanka

610x715x1365x598



### Wk440

44x650x748x374



### Koza AB/S/K

604x515x1052x410

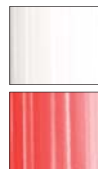

Koza AB/S/N/K

604x528x1086x418

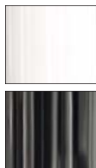

kW

8

<kW<

5,5-10,5



78



150



-



250





### Koza K5

509x452x628x406



7



5,5-9



76



130



150



118



250

### Koza K6

500x578x630x490



8



7-11



76



130



150



120



350

### Koza K6/W

500x578x630x500



8



5,4x10,5



76



130



120



350



2



### Koza K7

410x536x557x413

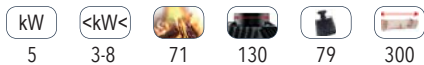

### Koza K8

491x666x629x382

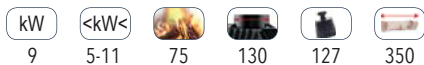

### Koza K9

529x766x660x546

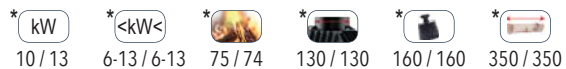

\*palivo: drevo / uhlie



**Koza K9/W**

529x766x660x556



kW 9  
 <kW> 5,3x12,7  
 76  
 150  
 160  
 350  
 kW 2,5

**Koza S10 Simple**

704x472x847x395



kW 6  
 <kW> 3-8  
 75  
 130  
 150  
 74  
 300

**Koza K10**

508x362x685x548



kW 10  
 <kW> 6-13  
 75  
 130  
 150  
 111  
 350

**Koza S10 Barril**

704x510x848x395



kW 6  
 <kW> 3-8  
 75  
 130  
 150  
 81,5  
 300

**Koza Alicja/PW**

845x662x991x396



kW 15  
 <kW> 8-19  
 79  
 180  
 136  
 350  
 kW 12

**Koza S10 Orasa**

510x540x860x389



kW 6  
 <kW> 3-8  
 75  
 130  
 150  
 128  
 300

Koza AB

604x515x1052x410

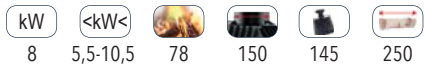

Koza AB/S

604x515x1052x410

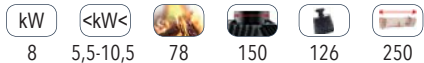

Koza AB/S/N

604x528x1086x418

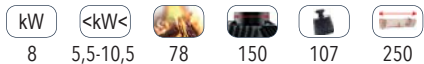

Lakované

---

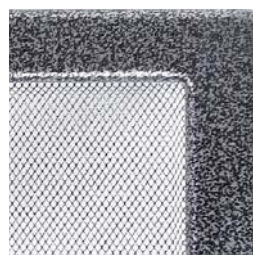
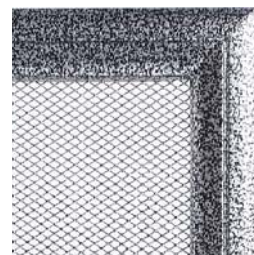
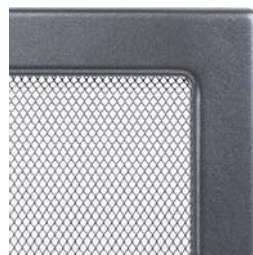

Pokované



Galvanizované

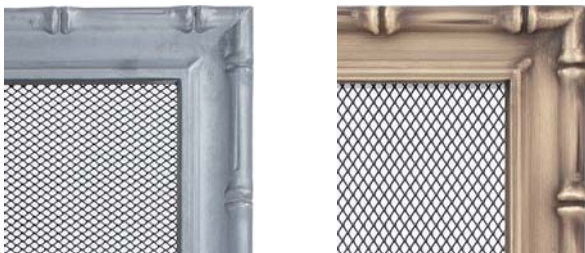



ABC

---



Rozmery:  
17x17, 17x30, 17x37, 17x49, 22x22, 22x30, 22x37, 22x45 cm/cm

Čistý prierez mriežky:  
72,9; 144,3; 180,3; 236,5; 126,5; 184,6; 239,2; 301,8 cm<sup>2</sup>/cm<sup>2</sup>

Tunel

---



Rozmery:  
6x40, 6x60, 6x80, 6x100 cm/cm

Čistý prierez mriežky:  
112, 172, 232, 292 cm<sup>2</sup>/cm<sup>2</sup>

Dekoračné



17x17, 22x22 cm/cm

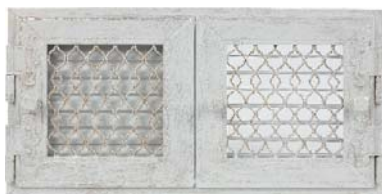

17x17, 22x22 cm/cm



17x17, 22x22 cm/cm



17x17, 22x22 cm/cm



28x33 cm/cm



35x44 cm/cm



30x30 cm/cm



22x44 cm/cm



## Mila Tunnel

---



Rozmery:  
12x90, 14x113,2 cm/cm

## Luft

---



Rozmery:  
6x40, 6x60, 6x80, 6x100, 9x40, 9x60, 9x80, 9x100 cm/cm

Čistý prierez mriežky:  
112, 172, 232, 292, 222, 342, 462, 582 cm<sup>2</sup>/cm<sup>2</sup>

## Luft rohové

---

Dostupné farby: biela, krémová, grafitová, čierna



Rozmery:  
56x56x9, 76,6x54,7x9, 54,7x76,6x9, 6x56x6, 76,6x54,7x6, 54,7x76,6x6 cm/cm

Čistý prierez mriežky:  
504, 612, 612, 264, 321, 321 cm<sup>2</sup>/cm<sup>2</sup>

## Fresh

---





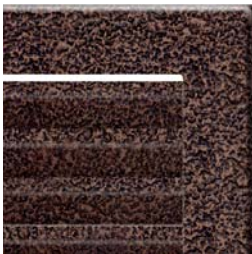
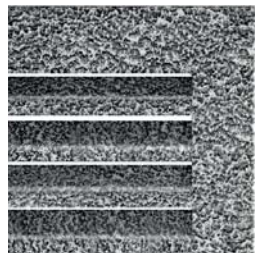
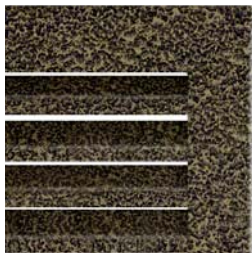

Rozmery:

17x17, 17x30, 17x37, 17x49, 17x70 cm/cm

Čistý prierez mriežky:

103, 215, 275, 369, 558 cm<sup>2</sup>/cm<sup>2</sup>

Mriežky podlahové



Rozmery:

164x94, 162x162, 212x102, 414x104, 613x103 mm/mm

Čistý prierez mriežky:

40, 60, 45, 100, 185 cm<sup>2</sup>/cm<sup>2</sup>



## Okrúhle

---



Rozmery:  
10; 12,5; 15 cm/cm

Čistý prierez mriežky:  
60, 70, 80 cm<sup>2</sup>/cm<sup>2</sup>

## Mriežky na objednávku

---



Vyrábame mriežky na zákazku podľa individuálnych požiadaviek zákazníka. Mriežky sú k dispozícii v štandardných farbách našej štandardnej ponuky.

## Dostupné rozmery mriežok

Označenie	Rozmer osadzovacieho otvoru (mm)	Rozmer mriežok (mm)	Rozmer mriežok so žalúziou (mm)	Mriežka Diana (mm)	Mriežka Diana so žalúziou (mm)	Mriežka rustikálna (mm)	Mriežka rustikálna so žalúziou (mm)	Mriežka Oskar (mm)	Mriežka Oskar so žalúziou (mm)	Čistý prierez mriežky (cm <sup>2</sup> )
11x11	86x86	106x106	-	116x116	-	116x116	-	116x116	-	36
11x17	86x152	106x170	-	116x175	-	116x175	-	116x175	-	75
11x24	86x217	106x236	-	116x245	-	116x245	-	116x245	-	117
11x32	86x287	106x307	-	116x316	-	116x316	-	116x316	-	156
11x42	86x397	107x417	-	116x425	-	116x425	-	116x425	-	222
17x17	152x152	170x170	170x170	177x177	177x177	177x177	177x177	177x177	177x177	144
17x30	152x275	170x301	170x301	177x301	177x301	177x301	177x301	177x301	177x301	300
17x37	152x351	170x370	170x370	177x377	177x377	177x377	177x377	177x377	177x377	384
17x49	152x456	170x481	170x481	177x483	177x483	177x483	177x483	177x483	177x483	516
22x22	200x200	220x220	220x220	220x220	220x220	220x220	220x220	220x220	220x220	289
22x30	200x275	220x300	220x300	-	-	-	-	-	-	425
22x37	200x351	220x370	220x370	-	-	-	-	-	-	544
22x45	200x426	220x450	220x450	-	-	-	-	-	-	680

## Biokrby



Bezpieczeństwo  
Produkcja  
kontrolowana



www.tuv.com  
ID 0000044536

Naše biokrby získali certifikát bezpečnosti TÜV

## Rozměry:

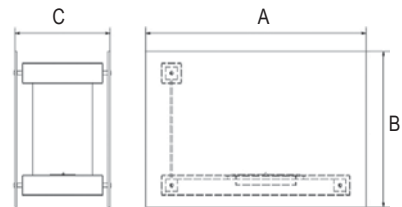
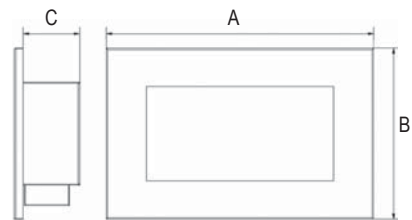

LINATE, HOTEL, HOTEL MINI, FOXTROT,  
HOTEL KRZAK, HOTEL MINI KRZAK

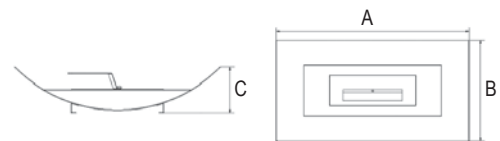

MISA, MISA MINI, INDIA, INDIA MINI, INDIA MAX, KILO



Biokrb je dostupný aj so sklom (voliteľné príslušenstvo)



Naše biokrbry sú vybavené bezpečným horákom - zásobníkom na bioalkohol.

Novinkou u bezpečnostných zásobníkov na bioalkohol je keramická hubka, ktorá sa v zásobníku nachádza. Hubka sa vyznačuje vynikajúcou absorpčnou schopnosťou. Použitím keramickej hubky sa znižuje spotreba paliva, ale najmä chráni pred rozliatím paliva zo zásobníka, v prípade nechceného prevrátenia horáku počas prevádzky.



Alpha

800x590x174



  lakovaná ocel' čierna

17

Charlie

880x510x174



  lakovaná ocel' čierna

20

Bravo

900x652x174



  lakovaná ocel' čierna

23,5

Charlie 2

460x780x174



  lakovaná ocel' čierna

14,5

Bravo 2

900x650x174



  lakovaná ocel' čierna

23

Delta Flat

900x400x120



  lakovaná ocel' čierna

13,2

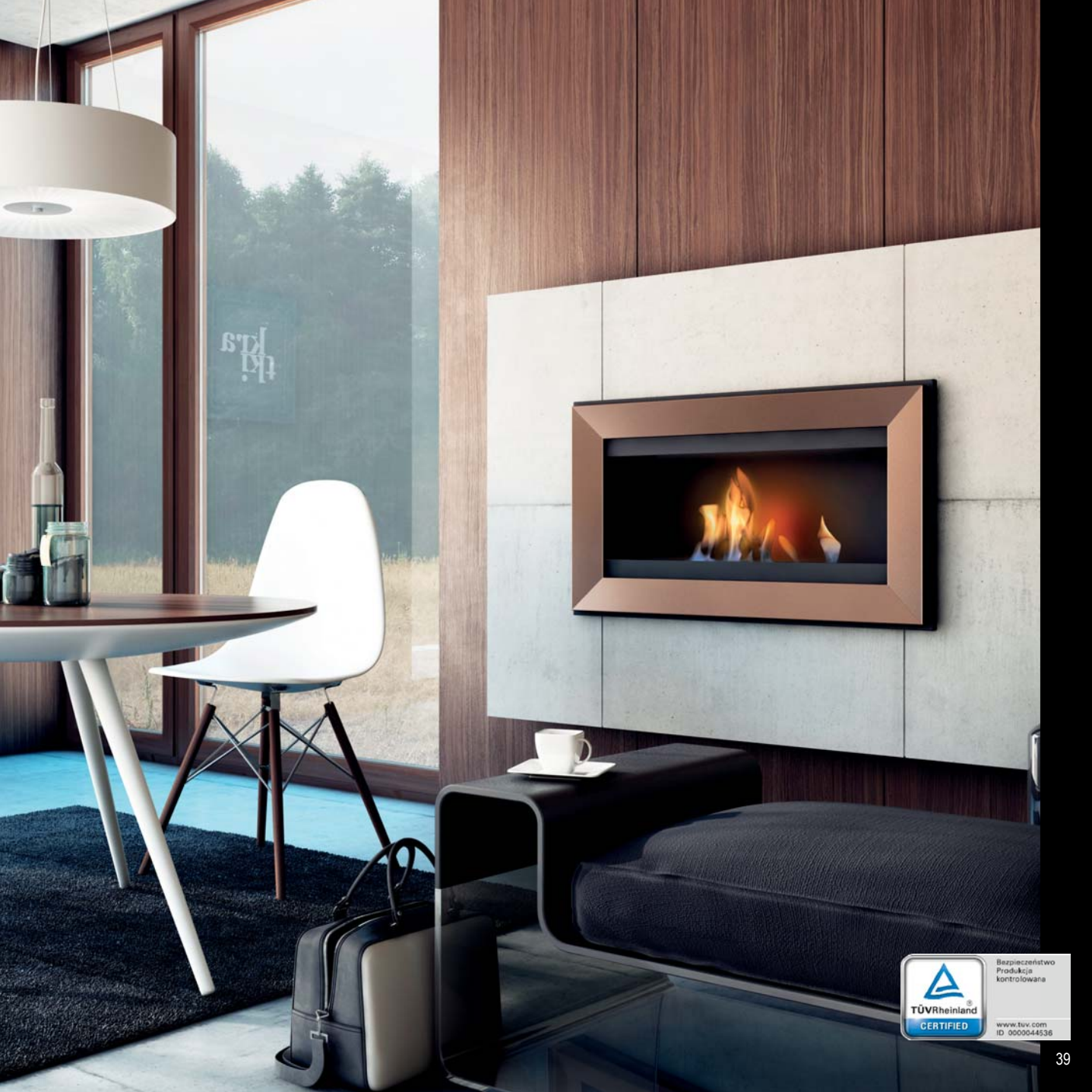

STYL  
K&H



Bezpieczeństwo  
Produkcja  
kontrolowana

www.tuv.com  
ID 000044536



## Delta

600x400x142



VERTICAL



QUBE



HORIZONTAL



NEREZ



ZEBRA



6,8



## Delta 2

900x400x142



VERTICAL



QUBE



HORIZONTAL



NEREZ



ZEBRA



8,4



lakovaná oceľ čierna

## Delta 3

1200x 400x142



13,5



lakovaná oceľ čierna





**Golf**

648x374x144



lakovaná ocel' čierna  
4,4

**Foxtrot**

360x702x290



lakovaná ocel' čierna  
15

**Galina**

354x218x142



lakovaná ocel' čierna  
4

**Hotel Krzak**

808x600x488



lakovaná ocel' čierna  
12

**Mike**

854x510x211



lakovaná ocel' čierna  
40

Systém dvojitého skla - voliteľné príslušenstvo

**Hotel Mini Krzak**

564x488x372



lakovaná ocel' čierna  
6





 <b>TÜV Rheinland</b> CERTIFIED	Bezpieczeństwo Produkcja kontrolowana
	<a href="http://www.tuv.com">www.tuv.com</a>
	ID 0000644536

**Hotel**

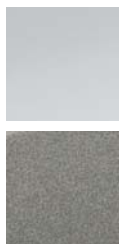
700x400x334





  lakovaná ocel čierna, sklo  
15,5

**India**

490x215x85





  lakovaná ocel čierna  
4

**Hotel Mini**

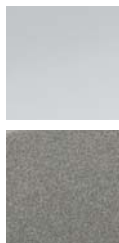
390x250x234





  lakovaná ocel čierna, sklo  
6

**India Mini**

340x155x70





  lakovaná ocel čierna  
2

**Kilo**

590x350x85





  lakovaná ocel čierna, nerez  
7

**India Max**

670x247x100



  lakovaná ocel čierna  
7

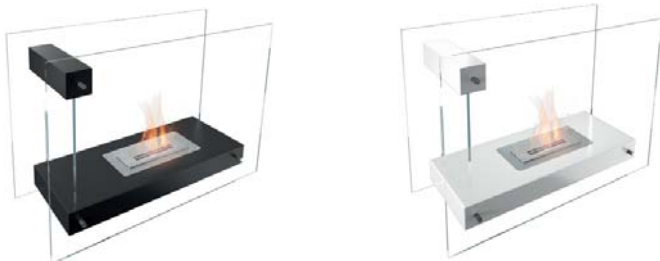

61  DTD + dýha, sklo

Ďalšie farebné prevedenia LINATE sú dostupné na objednávku:



Orech prírodný



Teak

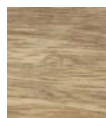

Borovica Bariòle



Orech pruhovaný



Zebrano svetlé

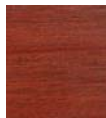

Mahagón

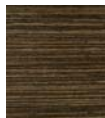

Wenge

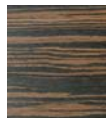

Eben



Dub bielený



Zebrano tmavé

Textúry a farby dýh na fotografiách sa môžu mierne líšiť od dodávaného produktu. Uvedené farby by mali byť považované za orientačné

Juliet

1800x650x142



38



lakovaná ocel čierna, nerez

Juliet 1500

1500x650x142



27



lakovaná ocel čierna, nerez

Juliet 1100

1100x650x142



21



lakovaná ocel čierna, nerez



Bezpieczeństwo  
Produkcja  
kontrolowana

www.tuv.com  
ID: 0000044536



Lima

1000x700x197



22,6



lakovaná oceľ čierna, nerez

Mila

1409x764x222



23



lakovaná oceľ čierna, nerez

Quad

685x534x185



11



lakovaná oceľ čierna



VERTICAL



HORIZONTAL



QUBE



NEREZ

Quebec

1150x398x295



45



lakovaná oceľ čierna

Oscar

900x630x190,5



19



lakovaná oceľ čierna, SKLO

Af

779x551x260



21



lakovaná oceľ čierna, nerez





Misa

717x400x171



8,5



lakovaná ocel' čierna

Misa Mini

470x260x130



4



lakovaná ocel' čierna

Papa

650x900x143



12



lakovaná ocel' čierna





**Papa Morpho**

650x900x143



12,5



lakovaná ocel čierna, nerez

**Papa Manhattan**

650x900x143

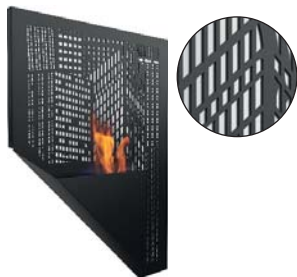

13,5



lakovaná ocel čierna, nerez

**Papa Smerf**

650x900x143



12,7





lakovaná ocel čierna, nerez



**Romeo**

359x1135,5x209





  lakovaná oceľ čierna, nerez, sklo  
19

**Sierra**

408x1700x405





  lakovaná oceľ čierna, MDF biela  
48,5

**Legionis**

1215x1152x342





  lakovaná oceľ čierna, MDF biela  
85

**October**

1180x940x330





  lakovaná oceľ čierna, MDF biela  
56

**November**

1200x1035x295





  lakovaná oceľ čierna, MDF biela  
52

**February**

1105x962x295





  lakovaná oceľ čierna, MDF biela  
54

December

1262x1071x325





  lakovaná oceľ čierna, MDF biela  
64

January

1067x1066x252





  lakovaná oceľ čierna, MDF biela  
52

Planet

1180x975x331



  lakovaná oceľ čierna, MDF biela  
81





Bezpieczeństwo  
Produkcja  
kontrolowana

www.tuv.com  
ID: 0009044536

April

1230x983x325





  lakovaná oceľ čierna, MDF biela  
68

May

1115x880x315





  lakovaná oceľ čierna, MDF biela  
54

July

1091x969x275





  lakovaná oceľ čierna, MDF biela  
55

Quaerere

1212x983x332





  lakovaná oceľ čierna, MDF biela  
63,5

March

1000x857x250





  lakovaná oceľ čierna, MDF biela  
49

Egzul

1130x973x315



  lakovaná oceľ čierna, MDF biela  
68,5

Ball

848,5x850x181,5



lakovaná oceľ čierna, MDF biela

28,5

June



čoskoro



Bezpieczeństwo  
Produkcja  
kontrolowana

www.tuv.com  
ID 0000044336

Vyrábame biokrby na zákazku podľa individuálnych požiadaviek zákazníka.



muc & scott interiors



BIO-DECO je tekuté palivo určené do biokrbov ako ekologický zdroj energie. Je bez zápachu a bez dymu. Biopalivo bolo testované a schválené pre použitie v rámci Národného inštitútu verejného zdravia. 1 liter biopaliva sa spotrebuje od 2 do 5 hodín - v závislosti na veľkosti plameňa. Biopalivo je 100% ekologický produkt.



Okrasné kamene sú určené ako dekorácia pre závesné a tiež voľne stojace biokrby. Ideálne zdôrazňujú ich vzhľad a dodajú im neopísateľné čaro. Sú odolné voči vysokým teplotám. Farba biela.



Bezpečný a funkčný zapalovač, nastaviteľný plameň a plnenie plynom.



Keramické polienka sú ideálnou dekoráciou pre závesné a tiež voľne stojace biokrby. Ich vzhľad je vernou imitáciou rôznych druhov drevín. Sú odolné voči vysokým teplotám.



Horák - zásobník na bioalkohol pre arómatoterapiu

**ZOP PLUS, S.R.O.**

Nám. hrdinov 2/12,  
Chynorany 956 33, Slovakia  
Tel. +421/38/5424 502  
Fax +421/38/5423 254  
E-mail: [zop@zopkrby.sk](mailto:zop@zopkrby.sk)

Otváracie hodiny:

Po - Pi 8:15 - 17:00  
So 8:15 - 12:00  
Ne ZATVORENÉ



DOVOZCA PRE SR

**ZOP**<sup>®</sup>  
PLUS  
[www.zopkrby.sk](http://www.zopkrby.sk)